

FR-X Series

ANALOG ROCKWELL TYPE HARDNESS TESTER FR-XA

High Reliability with Simple Structure and Strong Body.
Economical Model made much of Utility.



(HARDNESS DISPLAY)

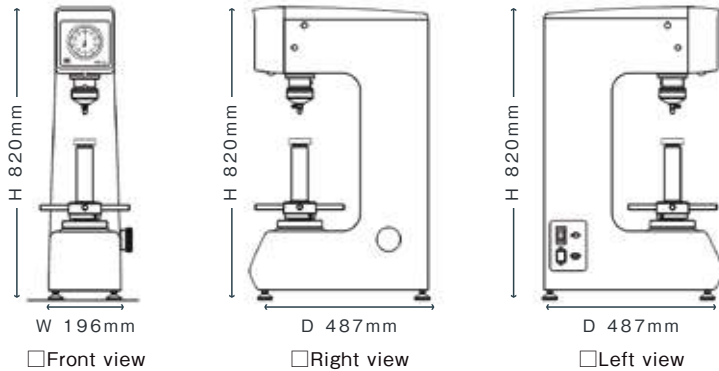

FR-XA SPECIFICATIONS

CONSTRUCTION		Dial Gauge / Motorized
LOAD	MINOR LOAD	N: 98.07 kgf: 10
	TEST LOAD	N: 588.4 980.7 1471 kgf: 60 100 150
		Dial Changing Type
MINOR LOAD POSITION SETTING		Manual setting on Green Range of Dial Gauge
LOAD CONTROL		Automatic (Application – Holding – Release)
START OPERATION		Manual start
LOAD REQUIRED TIME		1-8 sec (Constant speed)
DWELL TIME		Approx.2 sec (fixed)
SCALE DISPLAY		Read on Hardness Display For A,C,D Scale : White figures For Other Scale : Red figures
MAX.SPECIMEN HEIGHT		255mm (With lead screw cover attached : 135mm)
MAX.SPECIMEN DEPTH		165mm
DIMENSIONS		W196×D487×H820mm
WEIGHT		82kg
COMPLIANT STANDARD		Conform to ASTM E18 A1 • JIS B-7726
POWER SUPPLY		AC100/115/220V (Select either one when ordering), 50/60Hz

FR-XA STANDARD ACCESSORIES

CODE No.	ITEM	Q'TY
R-012	HARDNESS STANDARD BLOCK	HRC 1
R-014		HRBS or HRBW 1
R-002	DIAMOND INDENTER	1
R-004	STEEL BALL INDENTER OR CARBIDE BALL INDENTER (φ 1/16" / φ 1.588mm) ※SELECT EITHER ONE WHEN ORDERING	1
R-008	SPARE STEEL BALL OR SPARE CARBIDE BALL (φ 1/16" / φ 1.588mm) ※SELECT EITHER ONE WHEN ORDERING	When steel ball indenter is selected : 10 / When Carbide ball indenter is selected : 2
R-021	ANVIL	FLAT (φ 60mm) 1
R-022	ANVIL	V-SHAPE (LARGE) 1
R-042	POWER CABLE(3P-2.5m)	1
R-043	LEVEL ADJUSTING LEG	4
R-044	MACHINE COVER	1
—	INSTRUCTION AND MAINTENANCE MANUAL	1
—	HARDNESS CONVERSION CHART	1
R-045	ACCESSORY BOX	1



OPTIONAL ACCESSORIES



R-050
EXCEL DATA TRANSFER
SOFTWARE ATTACHED
WITH RS232C CABLE



R-001
DIGITAL PRINTER

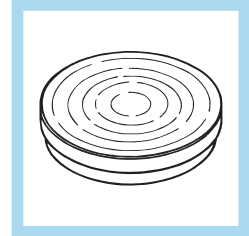

R-028
ROUND TABLE ϕ 200mm

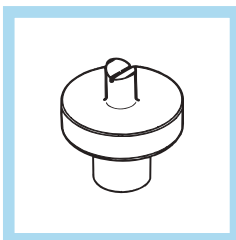

R-023
ANVIL V-SHAPE (Small)

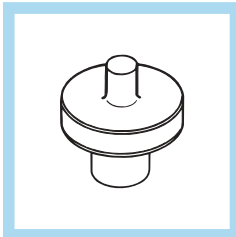

R-025
ANVIL SPOT
(Flat tip ϕ about 8.5 mm)

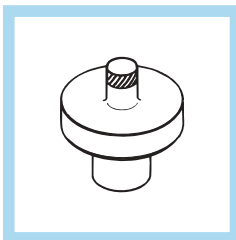

R-026
ANVIL CARBIDE SPOT

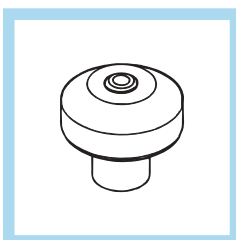

R-027
ANVIL DIAMOND SPOT

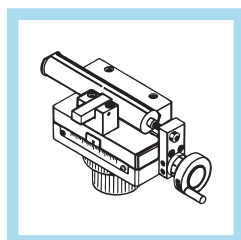

R-029
MICRO TEST TABLE
FOR JOMINY TEST

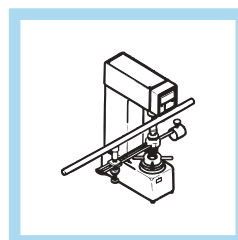

R-030
LONG SPECIMEN
TESTING JIG VARI-REST

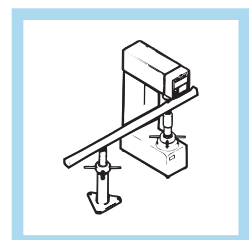

R-031
LONG SPECIMEN
TESTING JIG JACK-REST

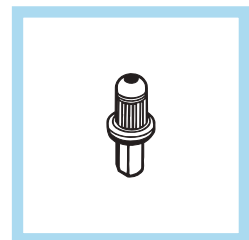

R-005
STEEL BALL INDENTER
 ϕ 1/8"

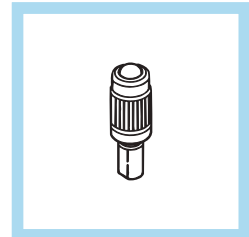

R-006
STEEL BALL INDENTER
 ϕ 1/4"

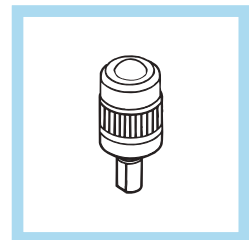

R-007
STEEL BALL INDENTER
 ϕ 1/2"